



A ALTEST[®]

ALUMINIUM PROFILES SYSTEMS

FRAM





PROFILES OVERVIEW

Profile shape	Profile code / description	Weight (gr/m)	Profile shape	Profile code / description	Weight (gr/m)
	1001 Frame profile	651		1024 Mullion profile	650
	1004 Frame profile	420		1031 Mosquito profile	501
	1005 Frame profile	1060		1041 Addition for double wing profile	288
	1011 Sash profile	688		1051 Drop defender profile	270
	1012 Sash profile	704		1071 Adaptor profile	211

WARNING: ALL OF THE PROFILE WEIGHTS ARE THEORETICAL.

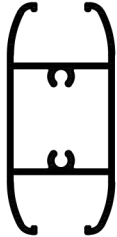
PROFILES OVERVIEW

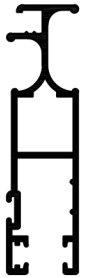
Profile shape	Profile code / description	Weight (gr/m)	Profile shape	Profile code / description	Weight (gr/m)
	2022 Sash profile	694			
	2042 Glass holder profile	230			
	300 0128 Mosquito profile	661			

WARNING: ALL OF THE PROFILE WEIGHTS ARE THEORETICAL.

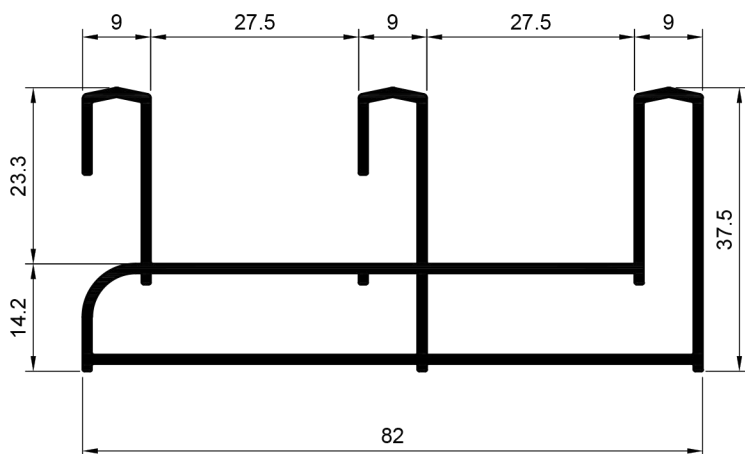
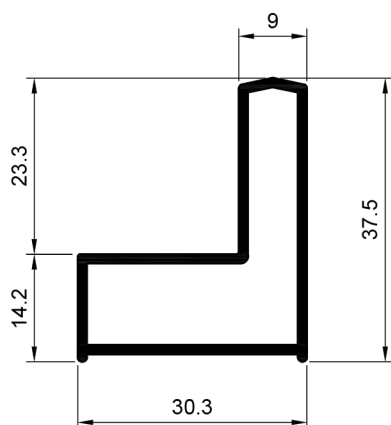
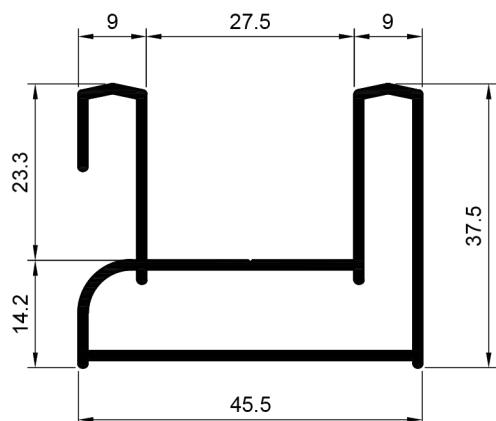

1001 Frame profile		Weight (gr/m)	I_x/ I_y (cm ⁴)	W_x/ W_y (cm ³)
		651	3,48/6,48	1,66/2,72
JOINTS	 APE 4		STOPPER	 AMS 11
BRUSHES	 AMS07			

1004 Frame profile		Weight (gr/m)	I_x/ I_y (cm ⁴)	W_x/ W_y (cm ³)
		420	2,06/1,63	0,91/0,86
JOINTS	 APE 4		STOPPER	 AMS 11
BRUSHES				

1005 Frame profile		Weight (gr/m)	I_x/ I_y (cm ⁴)	W_x/ W_y (cm ³)
		1060	5,56/28,81	2,55/6,81
JOINTS	 APE 4		STOPPER	 AMS 11
BRUSHES	 AMS07			

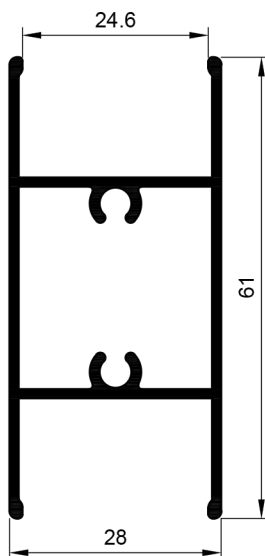
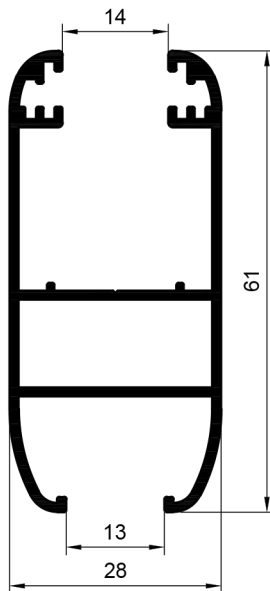
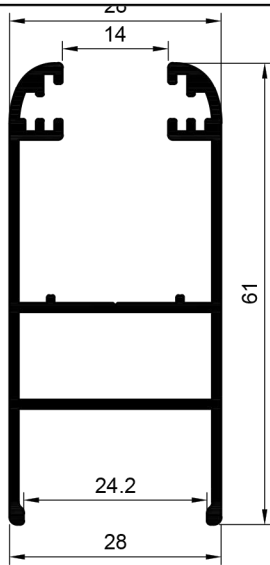

1011 Sash profile		Weight (gr/m)	I_x / I_y (cm ⁴)	W_x / W_y (cm ³)	
		688	7,97/3,37	2,47/2,41	
JOINTS			SHOCK DAMPER		
	APE 5				
ROLLER FIT		GASKETS		BRUSHES	

1012 Sash profile		Weight (gr/m)	I_x / I_y (cm ⁴)	W_x / W_y (cm ³)	
		704	8,53/3,28	2,70/2,34	
JOINTS			SHOCK DAMPER		
	APE 5				
ROLLER FIT		GASKETS		BRUSHES	

1024 Mullion profile		Weight (gr/m)	I_x / I_y (cm ⁴)	W_x / W_y (cm ³)	
		650	6,39/3,03	2,10/2,16	
JOINTS					
GASKETS					

FRAM

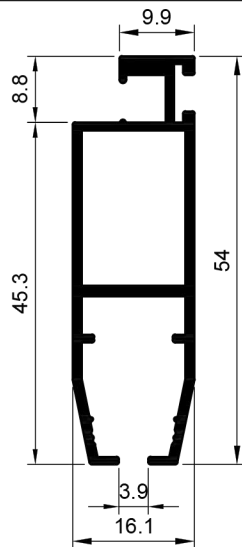

1031 Mosquito profile		Weight (gr/m)	I_x/ I_y (cm ⁴)	W_x/ W_y (cm ³)
		501	4,91/0,69	1,70/0,79
JOINTS	 AMS13 AMS14	ROLLER FIT	 AMS 20	
GASKETS	 UK 6	BRUSHES	 TZ 18.0	
MOSQUITO NET	FL 80; FL 100; FL 120; FL 140; FL 160.			

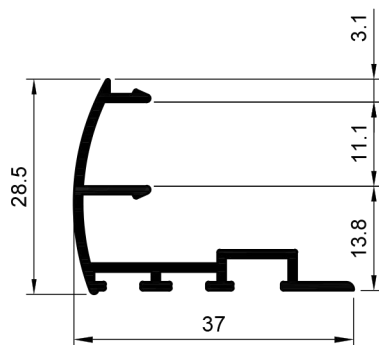

1041 Addition for double wing profile		Weight (gr/m)	I_x/ I_y (cm ⁴)	W_x/ W_y (cm ³)
		291	0,74/1,21	0,38/0,48
BRUSHES	 TZ 5.5 TZ 18.0			
COVER	 AMS 903			

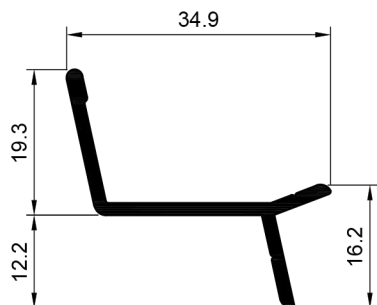

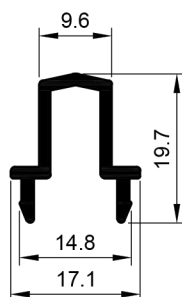

1051 Drop defender profile		Weight (gr/m)	I_x/ I_y (cm ⁴)	W_x/ W_y (cm ³)
		270	0,47/1,29	0,28/0,68
JOINTS				
GASKETS				

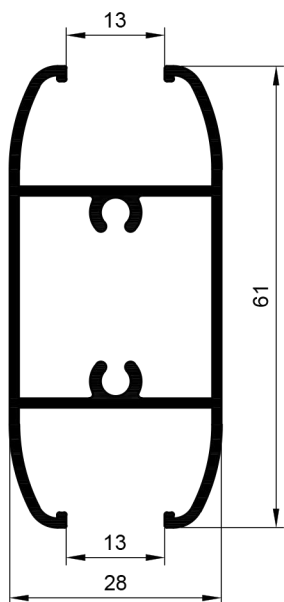

1071 Adaptor profile		Weight (gr/m)	I_x/ I_y (cm ⁴)	W_x/ W_y (cm ³)
		211	0,25/0,19	0,24/0,22
JOINTS	 VM46W			
GASKETS				

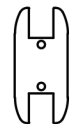

2022 Sash profile		Weight (gr/m)	I_x/ I_y (cm ⁴)	W_x/ W_y (cm ³)
		694	7,61/2,89	2,50/2,06
JOINTS	 VM 12212	COVER	 COVER CAP AMS 30	
GASKETS	 U 00.0; U 2;			

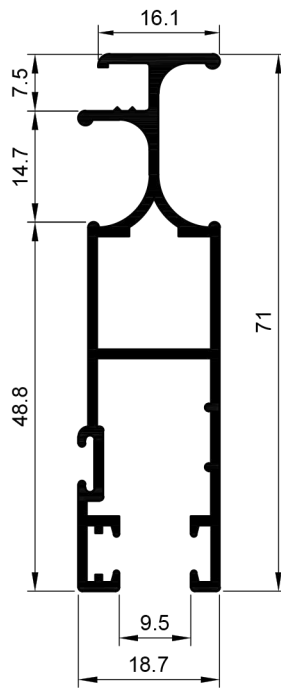
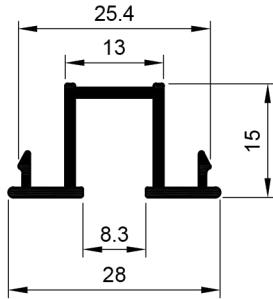

2042 Glass holder profile	Weight (gr/m)	I_x/ I_y (cm ⁴)	W_x/ W_y (cm ³)
	230	0,23/0,50	0,26/0,36
JOINTS			
GASKETS	 U 00.0; U 2;		

300 0128 Mosquito profile	Weight (gr/m)	I_x/ I_y (cm ⁴)	W_x/ W_y (cm ³)
	661	11,79/1,07	3,29/1,14
JOINTS	 APE 157	ROLLER FIT	 A 0103
BRUSHES	 TZ 5.5 TZ 18	BRUSHES	 UK 7
MOSQUITO NET	FL 80; FL 100; FL 120; FL 140; FL 160.		

ACCESSOIRES

CODE	DROWING	DESCRIPTION	PACKING TYPE		
APE 4		ANGLE FIT	1 Package	250 Counts	
APE 5		ANGLE FIT	1 Package	250 Counts	
APE 6		ANGLE FIT	1 Package	1000 Counts	
A 0204		ROLLER FIT	1 Package	150 Counts	
AMS 20		ROLLER FIT	1 Package	300 Counts	
A 0103		ROLLER FIT	1 Package	300 Counts	
AMS 13		ANGEL FIT	1 Package	150 Counts	
AMS 14		ANGEL FIT	1 Package	150 Counts	
APE 157		ANGEL FIT	1 Package	150 Counts	
A 0330		SHOCK DAMPER	1 Package	640 Counts	

ACCESSOIRES

CODE	DROWING	DESCRIPTION	PACKING TYPE	
AMS 11		STOPPER		
D 7610		LOCKING CUP + HANDLE	1 Package	30 Counts
UK 6		EPDM gasket for 1031		
UK 7		EPDM gasket for 300 0128		
FL 80; FL 100; FL 120; FL 140; FL 160.		MOSQUITO NET		
U 00.0; U 2;		EPDM gasket for glass fixing		

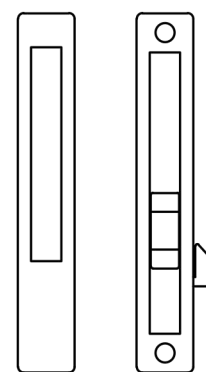
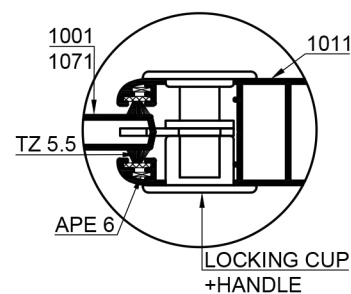

LOCKING CUP + HANDLE